

FILE: P:\ENG\PROD\DOC\RLW\RLW-

INDUCTANCE	LOSSES	WEIGHT
0.30 mH	78 Watts	13 Lbs

NO.	CHANGE DESCRIPTION	BY	DATE	C'K'D
-----	--------------------	----	------	-------

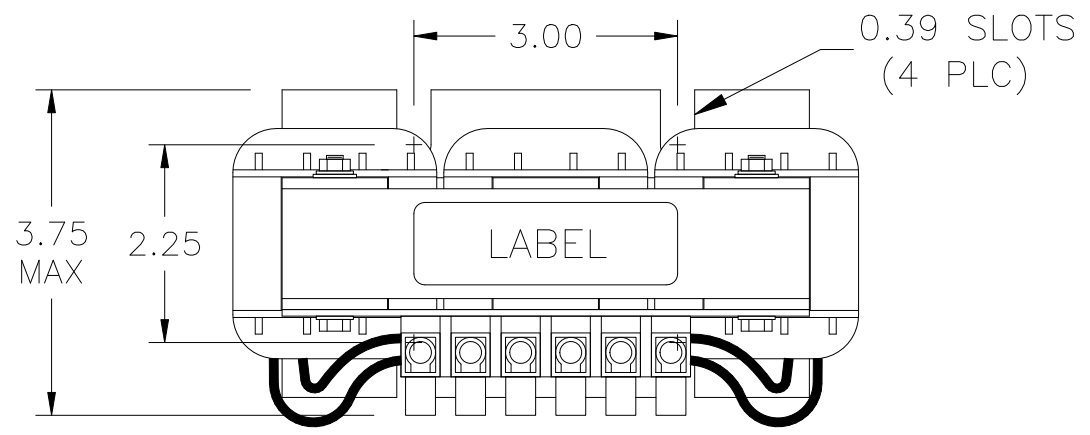

WIRE RANGE: 14-6 AWG

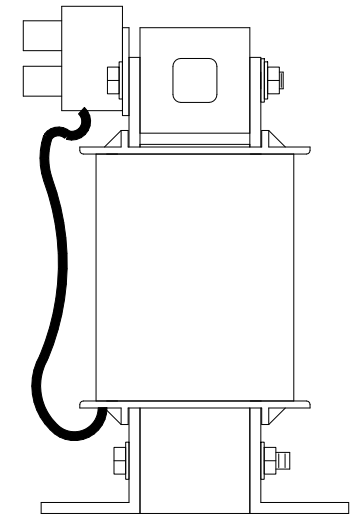
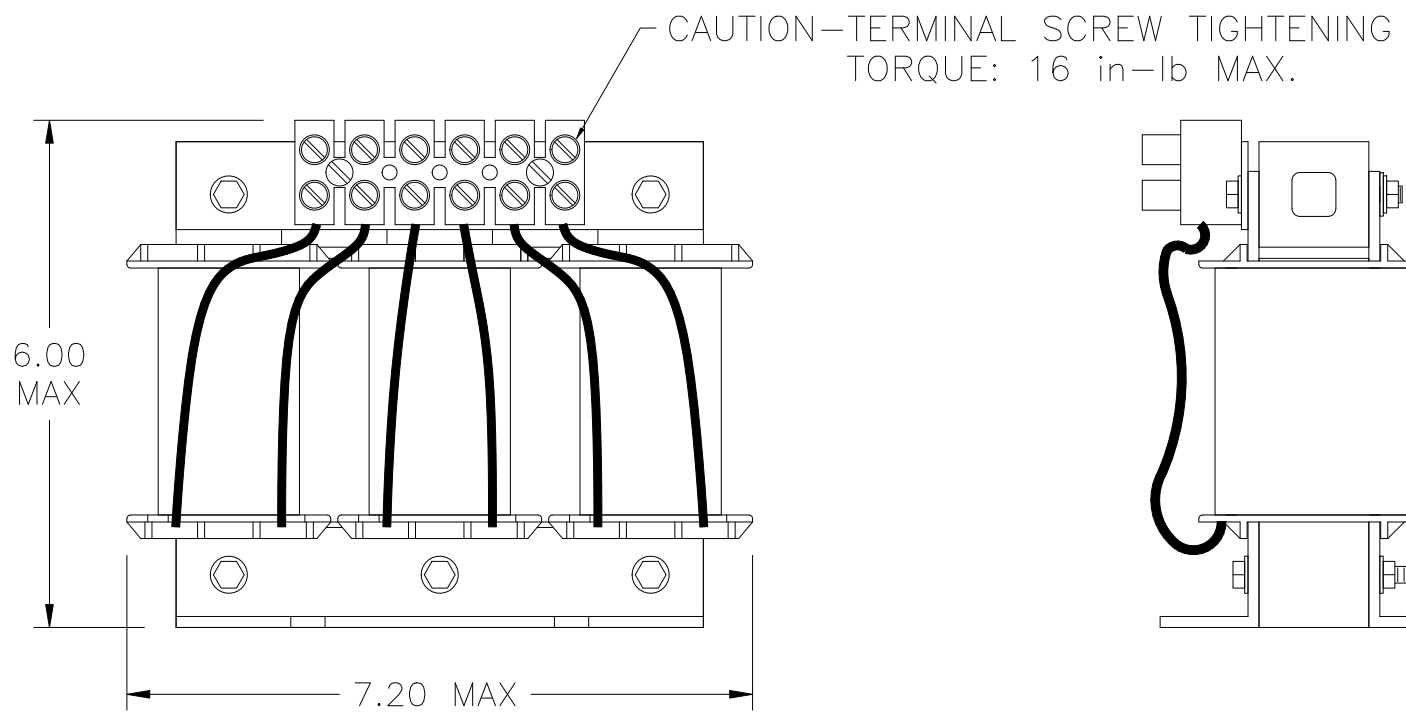

UNLESS OTHERWISE SPECIFIED, DIMENSIONS ARE IN INCHES [mm] AND TOLERANCES ARE:

DECI.	FRAC.
ANGLES	DRILLED HOLES

PART NAME:	3 PHASE REACTOR
DESCRIPTION:	OUTLINE DIMENSION
FINISH:	

MTE CORPORATION MENOMONEE FALLS, WISCONSIN			
RLW-004601			REV. 01
SCALE	NTS	DATE	1/21/09
REF.	DR. BY	BF	APP'D